

Amphenol Aerospace

CF-020011-433

Thermal Analysis: Added Inphi PHYs

April 9, 2020



Contents

Objectives	<u>3</u>
Approach	<u>4</u>
Thermal Model Setup Details	<u>5 - 12</u>
Overview	
Thermal Data	
Thermal Analysis	<u>13 - 30</u>
Results Summary	
Plots	
Recommendations	

Objectives

1. To determine that the critical components on the CF-170300-219 and CF-170300-220 boards are within their thermal limits:

a) **23°C at sea level**

b) **-54°C at 70,000 ft**

c) **55°C at sea level**

d) **71°C at sea level**

At the three different power levels:

a) **L3 Config.** – Total Power of 244.37W

b) **All 10G Op.** - Total Power of 290.06W

c) **Worst-case** – Total Power of 390.05W

2. To determine the temperature of the cold plate to keep all the ICs within operating limits within the specified environments.

Approach

1. This analysis was done using FloTHERM XT V2019.3 CFD software.
2. The model was evaluated with solid conduction only with a fixed temperature applied to the cooling surface. The fixed temperature was initially assumed to be of the same value as the ambient temperature and margins shall be used to determine the required cooling surface/cold plate temperature.
3. The thermal model was created from the cf-020011-433m_asm_thermal_033020.stp simplified for thermal analysis.
4. The boards were modeled based on the ODB++ files and initial estimates of the board stackup [files: CF-170300-219_REVA.tgz; CF-170300-220_REVA5_ECO.tgz and PCB Board Stack Up for Thermal Analysis.xlsx].
5. It was assumed that no neighboring devices were producing or sinking heat.
6. The thermal gap pads on the rear frame coupled to the Main PCB (CF-170300-220) are with $k = 5 \text{ W/m-K}$ at 0.100" thick while the thermal gap pads on the front frame coupled to the filter and DCDC converter (CF-170300-219) are with $k = 5 \text{ W/m-K}$ at 0.020" thick.
7. The critical components were modeled as 2-resistor networks with thermal resistance values found on the "Parts Thermal Characteristics.pdf". All other non-critical components were assigned a lumped thermal conductivity of 10 W/m-K .
8. Metal-to-metal contact resistance was set to $0.298 \text{ C-in}^2/\text{W}$ (equivalent to 5 micron air gap).

Thermal Model Setup

Thermal Model Setup – Overview: CF-170300-220 Board

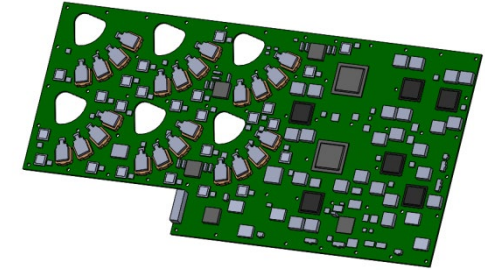
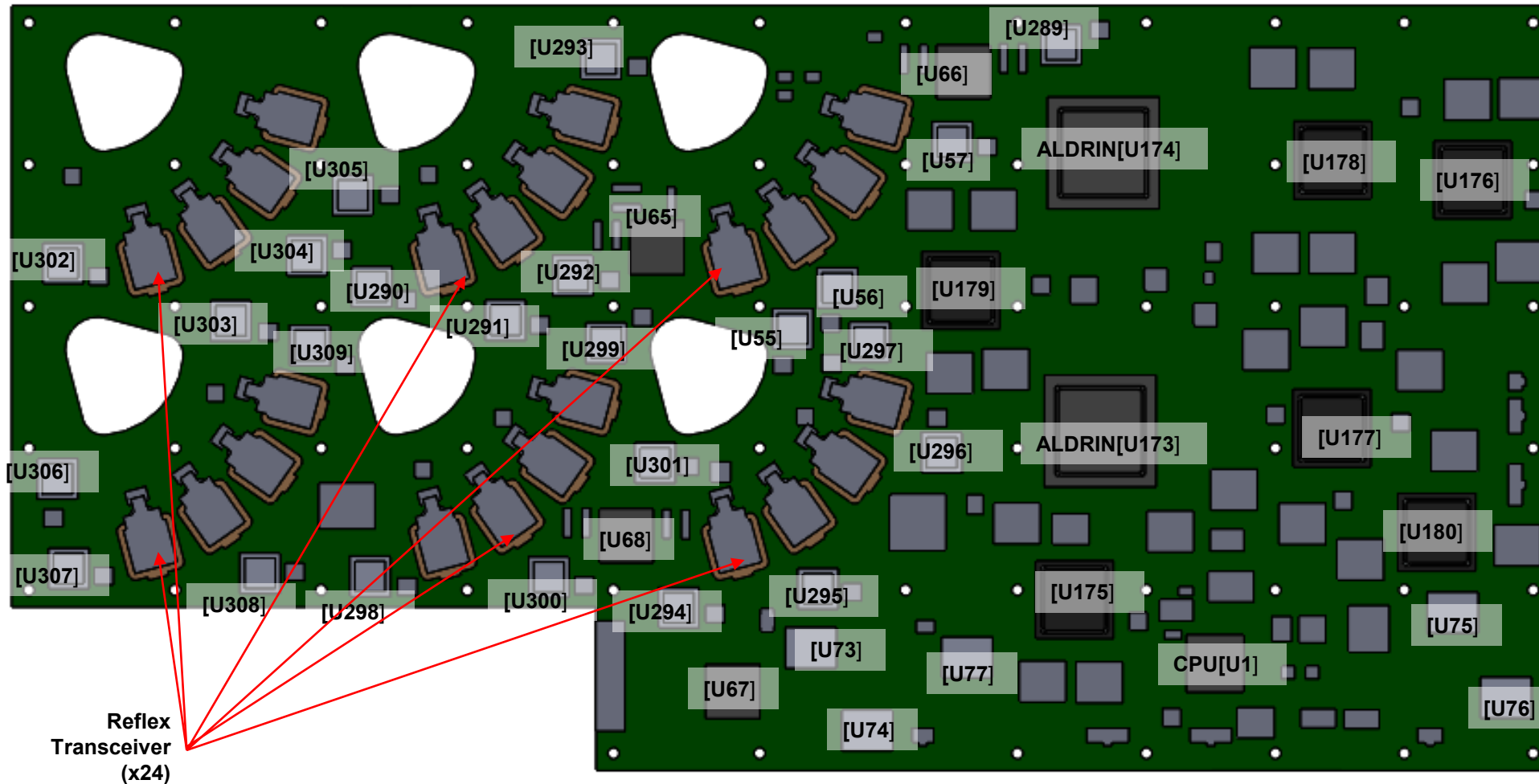

Thermal Model Setup –Overview: CF-170300-220 Board Thermal Gap Pads

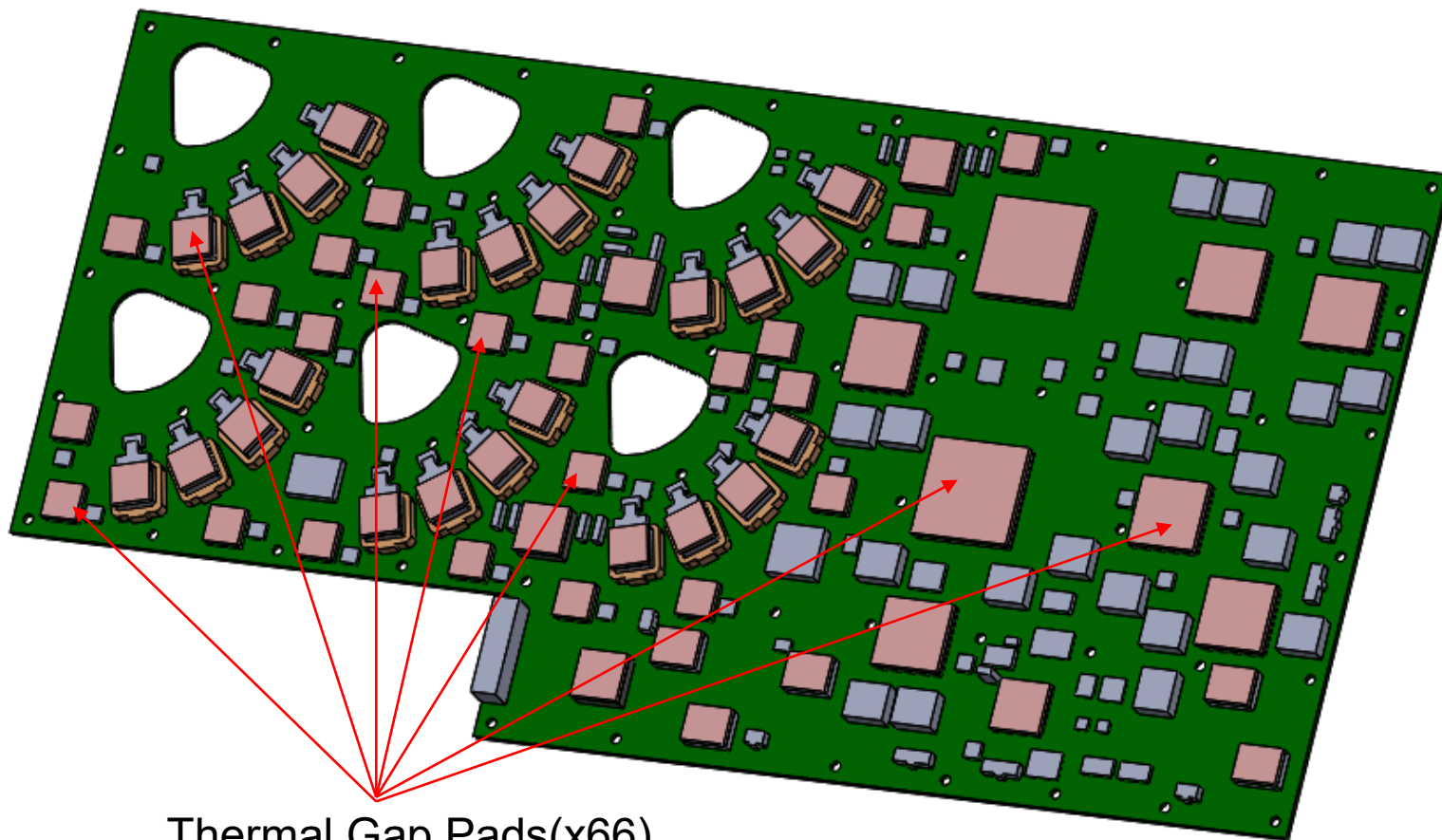

Thermal Gap Pads(x66)
[0.100" thick; $k = 5 \text{ W/m-K}$]

Thermal Model Setup –Overview: CF-170300-219 Board and Thermal Gap Pad

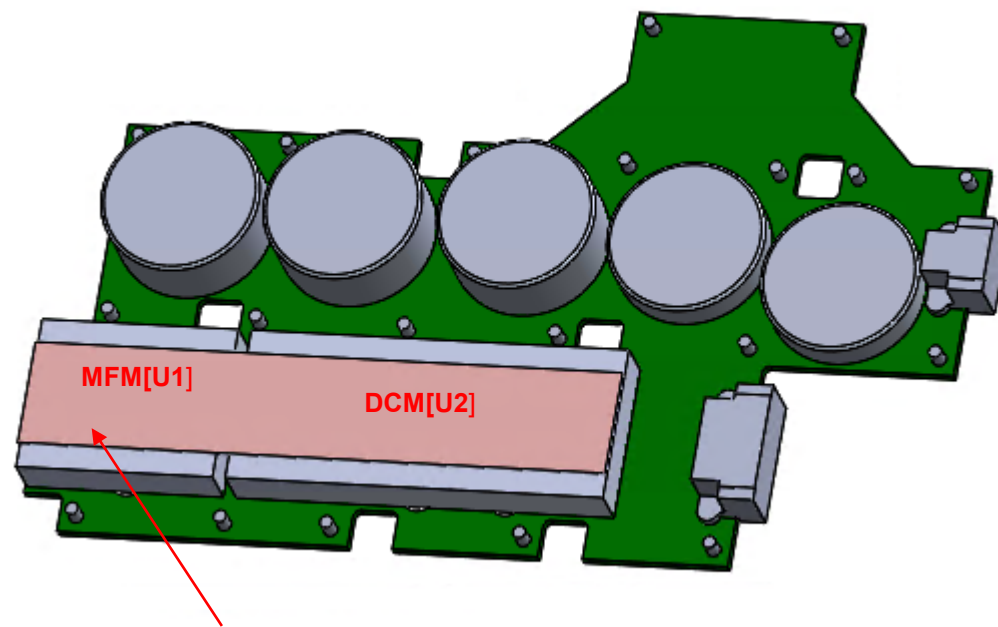

Thermal Gap Pad
[0.020" thick; $k = 5 \text{ W/m-K}$]

Thermal Model Setup –Overview: Housing

Rear Cover
[Al6061-T6]

Planar Thermal Source 1
Thermal FixedTemp

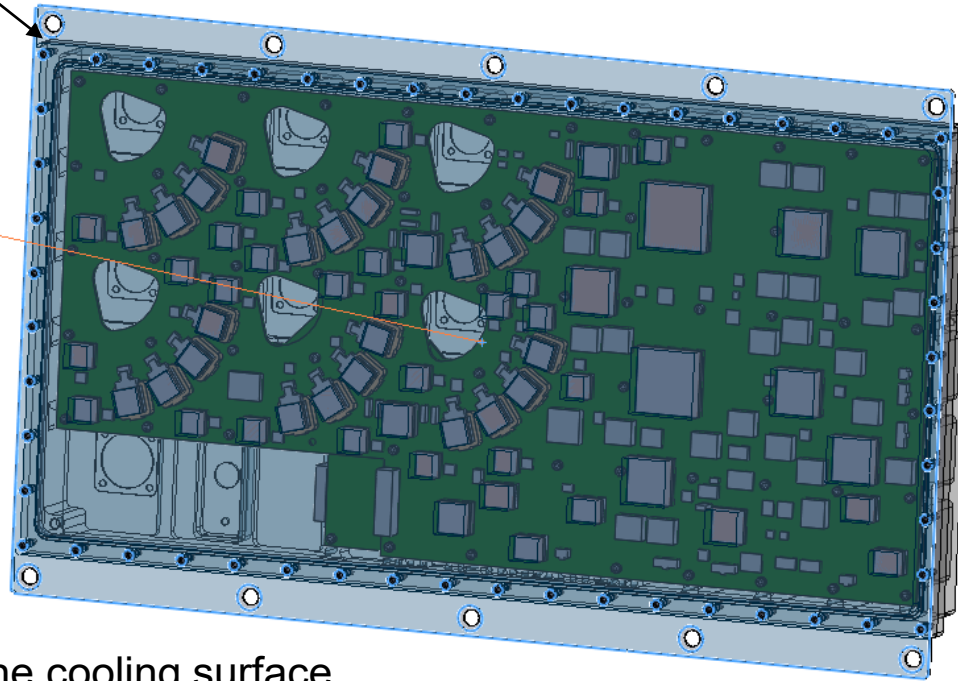

Front Housing
[Al6061-T6]

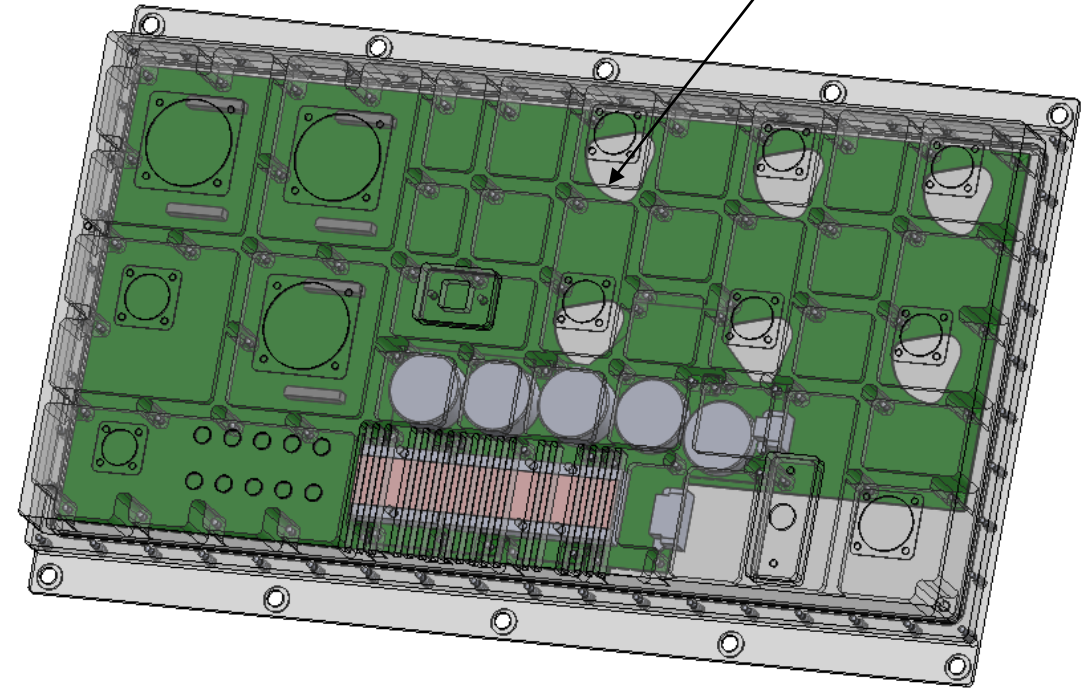

Note 3: The cooling surface (= rear cover outer surface) temperature is fixed in the thermal simulation. The value is chosen as the operating ambient temperature.

Note 1: The front housing and rear cover were shown as transparent to show the relative location of the boards.

Note 2: External dimensions of the housing are 19" x 11.5" x 2".

Screws (in frame assembly): [300 Series Stainless Steel]

Thermal Data

	CF-020011-433	L3 Config (W)			Thermal Resistance (°C/W)/Model		Maximum Temperature (°C)
	Component [Ref. Des.]	Qty	Per Component	Total	R _{JC}	R _{JB}	
CF-170300-219 PCB	MFM [U1]	1	3.18	3.18	14	4.7	100 (case)
	DCM [U2]	1	21.22	21.22	2.33	1.31	125 (internal)
	-219 PCB (Misc. spread)	1	0.98	0.98			
CF-170300-220 PCB	CPU [U1]	1	4.67	4.67	2.57	6.89	115 (junction)
	LTM4650 [U65]	1	1.45	1.45	3.7	1.5	125 (junction)
	LTM4650 [U66]	1	1.52	1.52	3.7	1.5	125 (junction)
	LTM4650 [U67]	1	1.99	1.99	3.7	1.5	125 (junction)
	LTM4650 [U68]	1	1.52	1.52	3.7	1.5	125 (junction)
	MPM3686 [U74]	1	2.72	2.72	7.5	2.5	125 (junction)
	MPM3686 [U75]	1	1.15	1.15	7.5	2.5	125 (junction)
	MPM3686 [U76]	1	1.19	1.19	7.5	2.5	125 (junction)
	MPM3686 [U77]	1	0.84	0.84	7.5	2.5	125 (junction)
	Aldrin [U173]	1	24.48	24.48	0.16	1.72	110 (junction)
	Aldrin [U174]	1	22.97	22.97	0.16	1.72	110 (junction)
	Reflex Xcer [In Socket:U142 to U165]	24	0.9	21.60	Lumped Model k=113 W/m-K (Zamak zinc alloy)		85 (case)
	Quad PHY [U175]	1	13.12	13.12	0.3	2.6	105 (junction)
	Quad PHY [U176]	1	6.52	6.52	0.3	2.6	105 (junction)
	Quad PHY [U177]	1	13.12	13.12	0.3	2.6	105 (junction)
	Quad PHY [U178]	1	6.52	6.52	0.3	2.6	105 (junction)
	Quad PHY [U179]	1	6.52	6.52	0.3	2.6	105 (junction)
	Quad PHY [U180]	1	6.52	6.52	0.3	2.6	105 (junction)
	InPHI [U57, U289, U292, U293, U296, U297, U299, U301, U305]	9	2.85	25.65	4.5	12.7	85 (case)
	InPHI [U55, U56, U290, U291, U294, U295, U298, U300, U302, U303, U304, U306, U307, U308, U309]	15	3.1	46.50	4.5	12.7	85 (case)
	-220 PCB (Misc. spread)	1	8.42	8.42			
				Total	244.37		

Note: Thermal resistances from junction to case (R_{JC}) and from junction to board (R_{JB}) and thermal limits were taken from "Parts Thermal Characteristics.pdf". Items in red were based on typical values for a similar package.

Thermal Data (continued)

	CF-020011-433	All 10G Op. (W)			Thermal Resistance (°C/W)/Model		Maximum Temperature (°C)
	Component [Ref. Des.]	Qty	Per Component	Total	R _{JC}	R _{JB}	
CF-170300-219 PCB	MFM [U1]	1	3.88	3.88	14	4.7	100 (case)
	DCM [U2]	1	25.91	25.91	2.33	1.31	125 (internal)
	-219 PCB (Misc. spread)	1	1.19	1.19			
CF-170300-220 PCB	CPU [U1]	1	4.67	4.67	2.57	6.89	115 (junction)
	LTM4650 [U65]	1	2.26	2.26	3.7	1.5	125 (junction)
	LTM4650 [U66]	1	1.52	1.52	3.7	1.5	125 (junction)
	LTM4650 [U67]	1	2.26	2.26	3.7	1.5	125 (junction)
	LTM4650 [U68]	1	1.52	1.52	3.7	1.5	125 (junction)
	MPM3686 [U74]	1	2.74	2.74	7.5	2.5	125 (junction)
	MPM3686 [U75]	1	1.73	1.73	7.5	2.5	125 (junction)
	MPM3686 [U76]	1	1.72	1.72	7.5	2.5	125 (junction)
	MPM3686 [U77]	1	1.26	1.26	7.5	2.5	125 (junction)
	Aldrin [U173]	1	24.48	24.48	0.16	1.72	110 (junction)
	Aldrin [U174]	1	24.48	24.48	0.16	1.72	110 (junction)
	Reflex Xcer [In Socket:U142 to U165]	24	0.9	21.60	Lumped Model k=113 W/m-K (Zamak zinc alloy)		85 (case)
	Quad PHY [U175]	1	13.12	13.12	0.3	2.6	105 (junction)
	Quad PHY [U176]	1	13.12	13.12	0.3	2.6	105 (junction)
	Quad PHY [U177]	1	13.12	13.12	0.3	2.6	105 (junction)
	Quad PHY [U178]	1	13.12	13.12	0.3	2.6	105 (junction)
	Quad PHY [U179]	1	13.12	13.12	0.3	2.6	105 (junction)
	Quad PHY [U180]	1	13.12	13.12	0.3	2.6	105 (junction)
	InPHI [U57, U289, U292, U293, U296, U297, U301, U299, U305]	9	3.34	30.06	4.5	12.7	85 (case)
	InPHI [U55, U56, U290, U291, U294, U295, U298, U300, U302, U303, U304, U306, U307, U308, U309]	15	3.34	50.10	4.5	12.7	85 (case)
-220 PCB (Misc. spread)	1	9.96	9.96				
			Total	290.06			

Note: Thermal resistances from junction to case (R_{JC}) and from junction to board (R_{JB}) and thermal limits were taken from "Parts Thermal Characteristics.pdf". Items in red were based on typical values for a similar package.

Thermal Data (continued)

	CF-020011-433	Worst-Case (W)			Thermal Resistance (°C/W)/Model		Maximum Temperature (°C)
	Component [Ref. Des.]	Qty	Per Component	Total	R _{JC}	R _{JB}	
CF-170300-219 PCB	MFM [U1]	1	5.66	5.66	14	4.7	100 (case)
	DCM [U2]	1	37.74	37.74	2.33	1.31	125 (internal)
	-219 PCB (Misc. spread)	1	1.74	1.74			
CF-170300-220 PCB	CPU [U1]	1	7.77	7.77	2.57	6.89	115 (junction)
	LTM4650 [U65]	1	3.1	3.10	3.7	1.5	125 (junction)
	LTM4650 [U66]	1	5.55	5.55	3.7	1.5	125 (junction)
	LTM4650 [U67]	1	3.1	3.10	3.7	1.5	125 (junction)
	LTM4650 [U68]	1	5.55	5.55	3.7	1.5	125 (junction)
	MPM3686 [U74]	1	4.32	4.32	7.5	2.5	125 (junction)
	MPM3686 [U75]	1	1.81	1.81	7.5	2.5	125 (junction)
	MPM3686 [U76]	1	2.86	2.86	7.5	2.5	125 (junction)
	MPM3686 [U77]	1	1.3	1.30	7.5	2.5	125 (junction)
	Aldrin [U173]	1	53.55	53.55	0.16	1.72	110 (junction)
	Aldrin [U174]	1	53.55	53.55	0.16	1.72	110 (junction)
	Reflex Xcer [In Socket:U142 to U165]	24	0.94	22.56	Lumped Model k=113 W/m-K (Zamak zinc alloy)		85 (case)
	Quad PHY [U175]	1	13.49	13.49	0.3	2.6	105 (junction)
	Quad PHY [U176]	1	13.49	13.49	0.3	2.6	105 (junction)
	Quad PHY [U177]	1	13.49	13.49	0.3	2.6	105 (junction)
	Quad PHY [U178]	1	13.49	13.49	0.3	2.6	105 (junction)
	Quad PHY [U179]	1	13.49	13.49	0.3	2.6	105 (junction)
	Quad PHY [U180]	1	13.49	13.49	0.3	2.6	105 (junction)
	InPHI [U57, U289, U292, U293, U296, U297, U301, U299, U305]	9	3.57	32.13	4.5	12.7	85 (case)
	InPHI [U55, U56, U290, U291, U294, U295, U298, U300, U302, U303, U304, U306, U307, U308, U309]	15	3.57	53.55	4.5	12.7	85 (case)
	-220 PCB (Misc. spread)	1	13.27	13.27			
				Total	390.05		

Note: Thermal resistances from junction to case (R_{JC}) and from junction to board (R_{JB}) and thermal limits were taken from "Parts Thermal Characteristics.pdf". Items in red were based on typical values for a similar package.

Thermal Analysis

Results Summary

Power Scenario		L3 Config.			All 10G Op.			Worst-case					
Parameters													
Ambient Temp., °C		23			23			23					
Fixed Temp. on Cooling Surface, °C		23			23			23					
Elevation, ft		0			0			0					
RESULTS													
Component [Ref. Des]	Min. Limit, °C	Max. Limit, °C	Limit Type	Power, W	Result, °C	Margin, °C	Power, W	Result, °C	Margin, °C	Power, W	Result, °C	Margin, °C	
CF-170300-219 PCB	MFM [U1]	-55	100	case	3.18	30.6	69.4	3.88	32.1	67.9	5.66	36.0	64.0
	DCM [U2]	-55	125	internal	21.22	66.1	58.9	25.91	75.4	49.6	37.74	99.1	25.9
CF-170300-220 PCB	CPU [U1]	-40	115	junction	4.67	41.7	73.3	4.67	42.3	72.7	7.77	53.9	61.1
	LTM4650 [U65]	-40	125	junction	1.45	31.4	93.6	2.26	34.6	90.4	3.1	38.3	86.7
	LTM4650 [U66]	-40	125	junction	1.52	32.5	92.5	1.52	33.3	91.7	5.55	49.3	75.7
	LTM4650 [U67]	-40	125	junction	1.99	34.5	90.5	2.26	36.0	89.0	3.1	40.8	84.2
	LTM4650 [U68]	-40	125	junction	1.52	32.6	92.4	1.52	33.2	91.8	5.55	47.5	77.5
	MPM3686 [U74]	-40	125	junction	2.72	43.5	81.5	2.74	44.3	80.7	4.32	55.1	69.9
	MPM3686 [U75]	-40	125	junction	1.15	34.0	91.0	1.73	38.9	86.1	1.81	41.2	83.8
	MPM3686 [U76]	-40	125	junction	1.19	33.5	91.5	1.72	37.8	87.2	2.86	45.5	79.5
	MPM3686 [U77]	-40	125	junction	0.84	34.2	90.8	1.26	37.1	87.9	1.3	40.0	85.0
	Aldrin [U173]	-40	110	junction	24.48	44.5	65.5	24.48	44.9	65.1	53.55	68.5	41.5
	Aldrin [U174]	-40	110	junction	22.97	42.9	67.1	24.48	44.6	65.4	53.55	68.4	41.6
	Reflex Xcer -Worst-case	-40	85	case	0.9	29.6	55.4	0.9	30.3	54.7	0.94	31.8	53.2
	Quad PHY [U175]	-40	105	junction	13.12	43.5	61.5	13.12	43.8	61.2	13.49	45.9	59.1
	Quad PHY [U176]	-40	105	junction	6.52	33.7	71.3	13.12	43.5	61.5	13.49	44.7	60.3
	Quad PHY [U177]	-40	105	junction	13.12	43.2	61.8	13.12	44.0	61.0	13.49	45.6	59.4
	Quad PHY [U178]	-40	105	junction	6.52	34.1	70.9	13.12	43.9	61.1	13.49	45.5	59.5
	Quad PHY [U179]	-40	105	junction	6.52	34.4	70.6	13.12	43.6	61.4	13.49	45.6	59.4
Quad PHY [U180]	-40	105	junction	6.52	34.1	70.9	13.12	43.6	61.4	13.49	44.9	60.1	

Results Summary (continued)

Power Scenario				L3 Config.			All 10G Op.			Worst-case			
Parameters													
Ambient Temp., °C					23		23		23		23		
Fixed Temp. on Cooling Surface, °C					23		23		23		23		
Elevation, ft					0		0		0		0		
RESULTS													
Component [Ref. Des]	Min. Limit, °C	Max. Limit, °C	Limit Type	Power, W	Result, °C	Margin, °C	Power, W	Result, °C	Margin, °C	Power, W	Result, °C	Margin, °C	
CF-170300-220 PCB	Inphi [U57]	-40	85	case	2.85	34.4	50.6	3.34	36.4	48.6	3.57	38.4	46.6
	Inphi [U289]	-40	85	case	2.85	34.6	50.4	3.34	36.6	48.4	3.57	39.0	46.0
	Inphi [U292]	-40	85	case	2.85	34.1	50.9	3.34	36.0	49.0	3.57	37.1	47.9
	Inphi [U293]	-40	85	case	2.85	33.8	51.2	3.34	35.6	49.4	3.57	36.6	48.4
	Inphi [U296]	-40	85	case	2.85	34.7	50.3	3.34	36.7	48.3	3.57	38.4	46.6
	Inphi [U297]	-40	85	case	2.85	34.4	50.6	3.34	36.4	48.6	3.57	37.7	47.3
	Inphi [U299]	-40	85	case	2.85	34.1	50.9	3.34	36.0	49.0	3.57	37.2	47.8
	Inphi [U301]	-40	85	case	2.85	34.5	50.5	3.34	36.4	48.6	3.57	37.9	47.1
	Inphi [U305]	-40	85	case	2.85	34.1	50.9	3.34	35.9	49.1	3.57	36.9	48.1
	Inphi [U55]	-40	85	case	3.1	35.4	49.6	3.34	36.5	48.5	3.57	37.8	47.2
	Inphi [U56]	-40	85	case	3.1	35.4	49.6	3.34	36.5	48.5	3.57	37.9	47.1
	Inphi [U290]	-40	85	case	3.1	35.2	49.8	3.34	36.2	48.8	3.57	37.2	47.8
	Inphi [U291]	-40	85	case	3.1	35.2	49.8	3.34	36.2	48.8	3.57	37.3	47.7
	Inphi [U294]	-40	85	case	3.1	35.4	49.6	3.34	36.4	48.6	3.57	38.0	47.0
	Inphi [U295]	-40	85	case	3.1	35.3	49.7	3.34	36.3	48.7	3.57	37.8	47.2
	Inphi [U298]	-40	85	case	3.1	35.1	49.9	3.34	36.1	48.9	3.57	37.2	47.8
	Inphi [U300]	-40	85	case	3.1	35.2	49.8	3.34	36.1	48.9	3.57	37.6	47.4
	Inphi [U302]	-40	85	case	3.1	34.7	50.3	3.34	35.6	49.4	3.57	36.5	48.5
	Inphi [U303]	-40	85	case	3.1	35.0	50.0	3.34	35.9	49.1	3.57	36.9	48.1
	Inphi [U304]	-40	85	case	3.1	35.1	49.9	3.34	36.0	49.0	3.57	37.0	48.0
Inphi [U306]	-40	85	case	3.1	35.0	50.0	3.34	35.9	49.1	3.57	36.9	48.1	
Inphi [U307]	-40	85	case	3.1	34.9	50.1	3.34	35.8	49.2	3.57	36.8	48.2	
Inphi [U308]	-40	85	case	3.1	35.0	50.0	3.34	36.0	49.0	3.57	37.0	48.0	
Inphi [U309]	-40	85	case	3.1	35.0	50.0	3.34	35.9	49.1	3.57	36.9	48.1	

15

- For the All 10G. Op. Power. at 23°C, the component with the least margin is the Inphi[U296] with ~48°C.

Results Summary (continued)

Power Scenario		L3 Config.			All 10G Op.			Worst-case					
Parameters													
Ambient Temp., °C		-54			-54			-54					
Fixed Temp. on Cooling Surface, °C		-54			-54			-54					
Elevation, ft		70,000			70,000			70,000					
RESULTS													
Component [Ref. Des]	Min. Limit, °C	Max. Limit, °C	Limit Type	Power, W	Result, °C	Margin, °C	Power, W	Result, °C	Margin, °C	Power, W	Result, °C	Margin, °C	
CF-170300-219 PCB	MFM [U1]	-55	100	case	3.18	-45.9	9.1	3.88	-44.3	10.7	5.66	-40.2	14.8
	DCM [U2]	-55	125	internal	21.22	-10.4	44.6	25.91	-0.9	54.1	37.74	23.1	78.1
CF-170300-220 PCB	CPU [U1]	-40	115	junction	4.67	-35.1	4.9	4.67	-34.6	5.4	7.77	-22.8	17.2
	LTM4650 [U65]	-40	125	junction	1.45	-45.5	-5.5	2.26	-42.3	-2.3	3.1	-38.6	1.4
	LTM4650 [U66]	-40	125	junction	1.52	-44.5	-4.5	1.52	-43.7	-3.7	5.55	-27.6	12.4
	LTM4650 [U67]	-40	125	junction	1.99	-42.4	-2.4	2.26	-40.9	-0.9	3.1	-36.0	4.0
	LTM4650 [U68]	-40	125	junction	1.52	-44.3	-4.3	1.52	-43.7	-3.7	5.55	-29.4	10.6
	MPM3686 [U74]	-40	125	junction	2.72	-33.4	6.6	2.74	-32.6	7.4	4.32	-21.7	18.3
	MPM3686 [U75]	-40	125	junction	1.15	-43.0	-3.0	1.73	-38.0	2.0	1.81	-35.7	4.3
	MPM3686 [U76]	-40	125	junction	1.19	-43.4	-3.4	1.72	-39.1	0.9	2.86	-31.4	8.6
	MPM3686 [U77]	-40	125	junction	0.84	-42.7	-2.7	1.26	-39.8	0.2	1.3	-36.8	3.2
	Aldrin [U173]	-40	110	junction	24.48	-32.4	7.6	24.48	-31.9	8.1	53.55	-8.1	31.9
	Aldrin [U174]	-40	110	junction	22.97	-33.9	6.1	24.48	-32.2	7.8	53.55	-8.3	31.7
	Reflex Xcer -Worst-case	-40	85	case	0.9	-47.4	-7.4	0.9	-46.7	-6.7	0.94	-45.1	-5.1
	Quad PHY [U175]	-40	105	junction	13.12	-33.4	6.6	13.12	-33.0	7.0	13.49	-30.9	9.1
	Quad PHY [U176]	-40	105	junction	6.52	-43.2	-3.2	13.12	-33.3	6.7	13.49	-32.1	7.9
	Quad PHY [U177]	-40	105	junction	13.12	-33.6	6.4	13.12	-32.9	7.1	13.49	-31.2	8.8
	Quad PHY [U178]	-40	105	junction	6.52	-42.8	-2.8	13.12	-33.0	7.0	13.49	-31.3	8.7
Quad PHY [U179]	-40	105	junction	6.52	-42.5	-2.5	13.12	-33.2	6.8	13.49	-31.2	8.8	
Quad PHY [U180]	-40	105	junction	6.52	-42.8	-2.8	13.12	-33.3	6.7	13.49	-31.9	8.1	

- The minimum limit was used to determine margins. For the All 10G. Op. Power. at -54°C, the component with the least margin is the Reflex Transceiver being ~7°C lower than the minimum limit.

Results Summary (continued)

Power Scenario				L3 Config.			All 10G Op.			Worst-case			
Parameters													
Ambient Temp., °C				-54			-54			-54			
Fixed Temp. on Cooling Surface, °C				-54			-54			-54			
Elevation, ft				70,000			70,000			70,000			
RESULTS													
Component [Ref. Des]	Min. Limit, °C	Max. Limit, °C	Limit Type	Power, W	Result, °C	Margin, °C	Power, W	Result, °C	Margin, °C	Power, W	Result, °C	Margin, °C	
CF-170300-220 PCB	Inphi [U57]	-40	85	case	2.85	-42.5	-2.5	3.34	-40.5	-0.5	3.57	-38.4	1.6
	Inphi [U289]	-40	85	case	2.85	-42.3	-2.3	3.34	-40.2	-0.2	3.57	-37.8	2.2
	Inphi [U292]	-40	85	case	2.85	-42.8	-2.8	3.34	-40.9	-0.9	3.57	-39.8	0.2
	Inphi [U293]	-40	85	case	2.85	-43.1	-3.1	3.34	-41.3	-1.3	3.57	-40.3	-0.3
	Inphi [U296]	-40	85	case	2.85	-42.2	-2.2	3.34	-40.2	-0.2	3.57	-38.4	1.6
	Inphi [U297]	-40	85	case	2.85	-42.5	-2.5	3.34	-40.5	-0.5	3.57	-39.1	0.9
	Inphi [U299]	-40	85	case	2.85	-42.8	-2.8	3.34	-40.9	-0.9	3.57	-39.7	0.3
	Inphi [U301]	-40	85	case	2.85	-42.4	-2.4	3.34	-40.5	-0.5	3.57	-39.0	1.0
	Inphi [U305]	-40	85	case	2.85	-42.8	-2.8	3.34	-41.0	-1.0	3.57	-39.9	0.1
	Inphi [U55]	-40	85	case	3.1	-41.5	-1.5	3.34	-40.4	-0.4	3.57	-39.0	1.0
	Inphi [U56]	-40	85	case	3.1	-41.5	-1.5	3.34	-40.3	-0.3	3.57	-39.0	1.0
	Inphi [U290]	-40	85	case	3.1	-41.7	-1.7	3.34	-40.7	-0.7	3.57	-39.7	0.3
	Inphi [U291]	-40	85	case	3.1	-41.7	-1.7	3.34	-40.7	-0.7	3.57	-39.5	0.5
	Inphi [U294]	-40	85	case	3.1	-41.5	-1.5	3.34	-40.4	-0.4	3.57	-38.8	1.2
	Inphi [U295]	-40	85	case	3.1	-41.6	-1.6	3.34	-40.5	-0.5	3.57	-39.1	0.9
	Inphi [U298]	-40	85	case	3.1	-41.8	-1.8	3.34	-40.8	-0.8	3.57	-39.7	0.3
	Inphi [U300]	-40	85	case	3.1	-41.7	-1.7	3.34	-40.7	-0.7	3.57	-39.3	0.7
	Inphi [U302]	-40	85	case	3.1	-42.2	-2.2	3.34	-41.3	-1.3	3.57	-40.3	-0.3
	Inphi [U303]	-40	85	case	3.1	-41.9	-1.9	3.34	-41.0	-1.0	3.57	-40.0	0.0
	Inphi [U304]	-40	85	case	3.1	-41.8	-1.8	3.34	-40.9	-0.9	3.57	-39.8	0.2
Inphi [U306]	-40	85	case	3.1	-41.9	-1.9	3.34	-41.0	-1.0	3.57	-40.0	0.0	
Inphi [U307]	-40	85	case	3.1	-42.0	-2.0	3.34	-41.0	-1.0	3.57	-40.1	-0.1	
Inphi [U308]	-40	85	case	3.1	-41.9	-1.9	3.34	-40.9	-0.9	3.57	-39.9	0.1	
Inphi [U309]	-40	85	case	3.1	-41.9	-1.9	3.34	-40.9	-0.9	3.57	-39.9	0.1	

- The minimum limit was used to determine margins. For the All 10G. Op. Power. at -54°C, the Inphi PHYs are marginal being 1°C below the minimum limit.

Results Summary (continued)

Power Scenario				L3 Config.			All 10G Op.			Worst-case			
Parameters													
Ambient Temp., °C					55			55				55	
Fixed Temp. on Cooling Surface, °C					55			55				55	
Elevation, ft					0			0				0	
RESULTS													
Component [Ref. Des]	Min. Limit, °C	Max. Limit, °C	Limit Type	Power, W	Result, °C	Margin, °C	Power, W	Result, °C	Margin, °C	Power, W	Result, °C	Margin, °C	
CF-170300-219 PCB	MFM [U1]	-55	100	case	3.18	62.5	37.5	3.88	64.0	36.0	5.66	67.9	32.1
	DCM [U2]	-55	125	internal	21.22	98.0	27.0	25.91	107.3	17.7	37.74	130.9	-5.9
CF-170300-220 PCB	CPU [U1]	-40	115	junction	4.67	73.7	41.3	4.67	74.2	40.8	7.77	85.9	29.1
	LTM4650 [U65]	-40	125	junction	1.45	63.4	61.6	2.26	66.6	58.4	3.1	70.3	54.7
	LTM4650 [U66]	-40	125	junction	1.52	64.5	60.5	1.52	65.2	59.8	5.55	81.2	43.8
	LTM4650 [U67]	-40	125	junction	1.99	66.5	58.5	2.26	68.0	57.0	3.1	72.8	52.2
	LTM4650 [U68]	-40	125	junction	1.52	64.6	60.4	1.52	65.2	59.8	5.55	79.5	45.5
	MPM3686 [U74]	-40	125	junction	2.72	75.4	49.6	2.74	76.3	48.7	4.32	87.1	37.9
	MPM3686 [U75]	-40	125	junction	1.15	65.9	59.1	1.73	70.9	54.1	1.81	73.2	51.8
	MPM3686 [U76]	-40	125	junction	1.19	65.5	59.5	1.72	69.8	55.2	2.86	77.5	47.5
	MPM3686 [U77]	-40	125	junction	0.84	66.2	58.8	1.26	69.0	56.0	1.3	72.0	53.0
	Aldrin [U173]	-40	110	junction	24.48	76.4	33.6	24.48	76.9	33.1	53.55	100.5	9.5
	Aldrin [U174]	-40	110	junction	22.97	74.9	35.1	24.48	76.6	33.4	53.55	100.3	9.7
	Reflex Xcer -Worst-case	-40	85	case	0.9	61.5	23.5	0.9	62.2	22.8	0.94	63.8	21.2
	Quad PHY [U175]	-40	105	junction	13.12	75.4	29.6	13.12	75.8	29.2	13.49	77.8	27.2
	Quad PHY [U176]	-40	105	junction	6.52	65.7	39.3	13.12	75.5	29.5	13.49	76.7	28.3
	Quad PHY [U177]	-40	105	junction	13.12	75.2	29.8	13.12	75.9	29.1	13.49	77.6	27.4
	Quad PHY [U178]	-40	105	junction	6.52	66.1	38.9	13.12	75.8	29.2	13.49	77.5	27.5
	Quad PHY [U179]	-40	105	junction	6.52	66.4	38.6	13.12	75.6	29.4	13.49	77.6	27.4
	Quad PHY [U180]	-40	105	junction	6.52	66.1	38.9	13.12	75.5	29.5	13.49	76.9	28.1

Results Summary (continued)

Power Scenario				L3 Config.			All 10G Op.			Worst-case			
Parameters													
Ambient Temp., °C					55			55				55	
Fixed Temp. on Cooling Surface, °C					55			55				55	
Elevation, ft					0			0				0	
RESULTS													
Component [Ref. Des]	Min. Limit, °C	Max. Limit, °C	Limit Type	Power, W	Result, °C	Margin, °C	Power, W	Result, °C	Margin, °C	Power, W	Result, °C	Margin, °C	
CF-170300-220 PCB	Inphi [U57]	-40	85	case	2.85	66.4	18.6	3.34	68.3	16.7	3.57	70.4	14.6
	Inphi [U289]	-40	85	case	2.85	66.6	18.4	3.34	68.6	16.4	3.57	71.0	14.0
	Inphi [U292]	-40	85	case	2.85	66.1	18.9	3.34	68.0	17.0	3.57	69.1	15.9
	Inphi [U293]	-40	85	case	2.85	65.8	19.2	3.34	67.6	17.4	3.57	68.6	16.4
	Inphi [U296]	-40	85	case	2.85	66.7	18.3	3.34	68.7	16.3	3.57	70.4	14.6
	Inphi [U297]	-40	85	case	2.85	66.3	18.7	3.34	68.3	16.7	3.57	69.7	15.3
	Inphi [U299]	-40	85	case	2.85	66.1	18.9	3.34	68.0	17.0	3.57	69.2	15.8
	Inphi [U301]	-40	85	case	2.85	66.5	18.5	3.34	68.3	16.7	3.57	69.9	15.1
	Inphi [U305]	-40	85	case	2.85	66.1	18.9	3.34	67.9	17.1	3.57	68.9	16.1
	Inphi [U55]	-40	85	case	3.1	67.4	17.6	3.34	68.5	16.5	3.57	69.8	15.2
	Inphi [U56]	-40	85	case	3.1	67.4	17.6	3.34	68.5	16.5	3.57	69.9	15.1
	Inphi [U290]	-40	85	case	3.1	67.2	17.8	3.34	68.2	16.8	3.57	69.2	15.8
	Inphi [U291]	-40	85	case	3.1	67.2	17.8	3.34	68.2	16.8	3.57	69.3	15.7
	Inphi [U294]	-40	85	case	3.1	67.4	17.6	3.34	68.4	16.6	3.57	70.0	15.0
	Inphi [U295]	-40	85	case	3.1	67.3	17.7	3.34	68.3	16.7	3.57	69.8	15.2
	Inphi [U298]	-40	85	case	3.1	67.1	17.9	3.34	68.1	16.9	3.57	69.1	15.9
	Inphi [U300]	-40	85	case	3.1	67.1	17.9	3.34	68.1	16.9	3.57	69.5	15.5
	Inphi [U302]	-40	85	case	3.1	66.7	18.3	3.34	67.6	17.4	3.57	68.5	16.5
	Inphi [U303]	-40	85	case	3.1	67.0	18.0	3.34	67.9	17.1	3.57	68.9	16.1
	Inphi [U304]	-40	85	case	3.1	67.0	18.0	3.34	68.0	17.0	3.57	69.0	16.0
Inphi [U306]	-40	85	case	3.1	67.0	18.0	3.34	67.9	17.1	3.57	68.9	16.1	
Inphi [U307]	-40	85	case	3.1	66.9	18.1	3.34	67.8	17.2	3.57	68.8	16.2	
Inphi [U308]	-40	85	case	3.1	67.0	18.0	3.34	68.0	17.0	3.57	69.0	16.0	
Inphi [U309]	-40	85	case	3.1	67.0	18.0	3.34	67.9	17.1	3.57	68.9	16.1	

19

- For the All 10G. Op. Power. at 55°C, the component with the least margin is the Inphi[296] with ~16°C margin.

Results Summary (continued)

Power Scenario				L3 Config.			All 10G Op.			Worst-case			
Parameters													
Ambient Temp., °C					71		71		71		71		
Fixed Temp. on Cooling Surface, °C					71		71		71		71		
Elevation, ft					0		0		0		0		
RESULTS													
Component [Ref. Des]	Min. Limit, °C	Max. Limit, °C	Limit Type	Power, W	Result, °C	Margin, °C	Power, W	Result, °C	Margin, °C	Power, W	Result, °C	Margin, °C	
CF-170300-219 PCB	MFM [U1]	-55	100	case	3.18	78.4	21.6	3.88	79.9	20.1	5.66	83.8	16.2
	DCM [U2]	-55	125	internal	21.22	113.9	11.1	25.91	123.2	1.8	37.74	146.8	-21.8
CF-170300-220 PCB	CPU [U1]	-40	115	junction	4.67	89.7	25.3	4.67	90.2	24.8	7.77	101.9	13.1
	LTM4650 [U65]	-40	125	junction	1.45	79.4	45.6	2.26	82.6	42.4	3.1	86.3	38.7
	LTM4650 [U66]	-40	125	junction	1.52	80.5	44.5	1.52	81.2	43.8	5.55	97.2	27.8
	LTM4650 [U67]	-40	125	junction	1.99	82.5	42.5	2.26	84.0	41.0	3.1	88.8	36.2
	LTM4650 [U68]	-40	125	junction	1.52	80.6	44.4	1.52	81.2	43.8	5.55	95.5	29.5
	MPM3686 [U74]	-40	125	junction	2.72	91.4	33.6	2.74	92.3	32.7	4.32	103.1	21.9
	MPM3686 [U75]	-40	125	junction	1.15	81.9	43.1	1.73	86.9	38.1	1.81	89.2	35.8
	MPM3686 [U76]	-40	125	junction	1.19	81.5	43.5	1.72	85.8	39.2	2.86	93.5	31.5
	MPM3686 [U77]	-40	125	junction	0.84	82.1	42.9	1.26	85.0	40.0	1.3	88	37.0
	Aldrin [U173]	-40	110	junction	24.48	92.4	17.6	24.48	92.9	17.1	53.55	116.5	-6.5
	Aldrin [U174]	-40	110	junction	22.97	90.9	19.1	24.48	92.6	17.4	53.55	116.3	-6.3
	Reflex Xcer -Worst-case	-40	85	case	0.9	77.5	7.5	0.9	78.2	6.8	0.94	79.8	5.2
	Quad PHY [U175]	-40	105	junction	13.12	91.4	13.6	13.12	91.8	13.2	13.49	93.8	11.2
	Quad PHY [U176]	-40	105	junction	6.52	81.7	23.3	13.12	91.5	13.5	13.49	92.7	12.3
	Quad PHY [U177]	-40	105	junction	13.12	91.2	13.8	13.12	91.9	13.1	13.49	93.6	11.4
	Quad PHY [U178]	-40	105	junction	6.52	82.1	22.9	13.12	91.8	13.2	13.49	93.5	11.5
	Quad PHY [U179]	-40	105	junction	6.52	82.3	22.7	13.12	91.5	13.5	13.49	93.6	11.4
	Quad PHY [U180]	-40	105	junction	6.52	82.1	22.9	13.12	91.5	13.5	13.49	92.9	12.1

Results Summary (continued)

Power Scenario				L3 Config.			All 10G Op.			Worst-case			
Parameters													
Ambient Temp., °C					71		71		71		71		
Fixed Temp. on Cooling Surface, °C					71		71		71		71		
Elevation, ft					0		0		0		0		
RESULTS													
Component [Ref. Des]	Min. Limit, °C	Max. Limit, °C	Limit Type	Power, W	Result, °C	Margin, °C	Power, W	Result, °C	Margin, °C	Power, W	Result, °C	Margin, °C	
CF-170300-220 PCB	Inphi [U57]	-40	85	case	2.85	82.4	2.6	3.34	84.3	0.7	3.57	86.4	-1.4
	Inphi [U289]	-40	85	case	2.85	82.6	2.4	3.34	84.6	0.4	3.57	87	-2.0
	Inphi [U292]	-40	85	case	2.85	82.1	2.9	3.34	84.0	1.0	3.57	85.1	-0.1
	Inphi [U293]	-40	85	case	2.85	81.8	3.2	3.34	83.6	1.4	3.57	84.6	0.4
	Inphi [U296]	-40	85	case	2.85	82.7	2.3	3.34	84.7	0.3	3.57	86.4	-1.4
	Inphi [U297]	-40	85	case	2.85	82.3	2.7	3.34	84.3	0.7	3.57	85.7	-0.7
	Inphi [U299]	-40	85	case	2.85	82.1	2.9	3.34	84.0	1.0	3.57	85.1	-0.1
	Inphi [U301]	-40	85	case	2.85	82.5	2.5	3.34	84.3	0.7	3.57	85.8	-0.8
	Inphi [U305]	-40	85	case	2.85	82.1	2.9	3.34	83.9	1.1	3.57	84.9	0.1
	Inphi [U55]	-40	85	case	3.1	83.4	1.6	3.34	84.5	0.5	3.57	85.8	-0.8
	Inphi [U56]	-40	85	case	3.1	83.4	1.6	3.34	84.5	0.5	3.57	85.8	-0.8
	Inphi [U290]	-40	85	case	3.1	83.2	1.8	3.34	84.1	0.9	3.57	85.2	-0.2
	Inphi [U291]	-40	85	case	3.1	83.2	1.8	3.34	84.2	0.8	3.57	85.3	-0.3
	Inphi [U294]	-40	85	case	3.1	83.4	1.6	3.34	84.4	0.6	3.57	86.0	-1.0
	Inphi [U295]	-40	85	case	3.1	83.3	1.7	3.34	84.3	0.7	3.57	85.7	-0.7
	Inphi [U298]	-40	85	case	3.1	83.1	1.9	3.34	84.1	0.9	3.57	85.1	-0.1
	Inphi [U300]	-40	85	case	3.1	83.1	1.9	3.34	84.1	0.9	3.57	85.5	-0.5
	Inphi [U302]	-40	85	case	3.1	82.7	2.3	3.34	83.6	1.4	3.57	84.5	0.5
	Inphi [U303]	-40	85	case	3.1	83.0	2.0	3.34	83.9	1.1	3.57	84.9	0.1
	Inphi [U304]	-40	85	case	3.1	83.0	2.0	3.34	84.0	1.0	3.57	85.0	0.0
Inphi [U306]	-40	85	case	3.1	83.0	2.0	3.34	83.9	1.1	3.57	84.9	0.1	
Inphi [U307]	-40	85	case	3.1	82.9	2.1	3.34	83.8	1.2	3.57	84.8	0.2	
Inphi [U308]	-40	85	case	3.1	83.0	2.0	3.34	84.0	1.0	3.57	85.0	0.0	
Inphi [U309]	-40	85	case	3.1	83.0	2.0	3.34	83.9	1.1	3.57	84.9	0.1	

- For the All 10G. Op. Power. at 71°C, the component with the least margin is the Inphi [U296] with -2.0°C .

CF-170300-220 Board Surface Temperature Plot

All 10G Op., 71°C , sea level

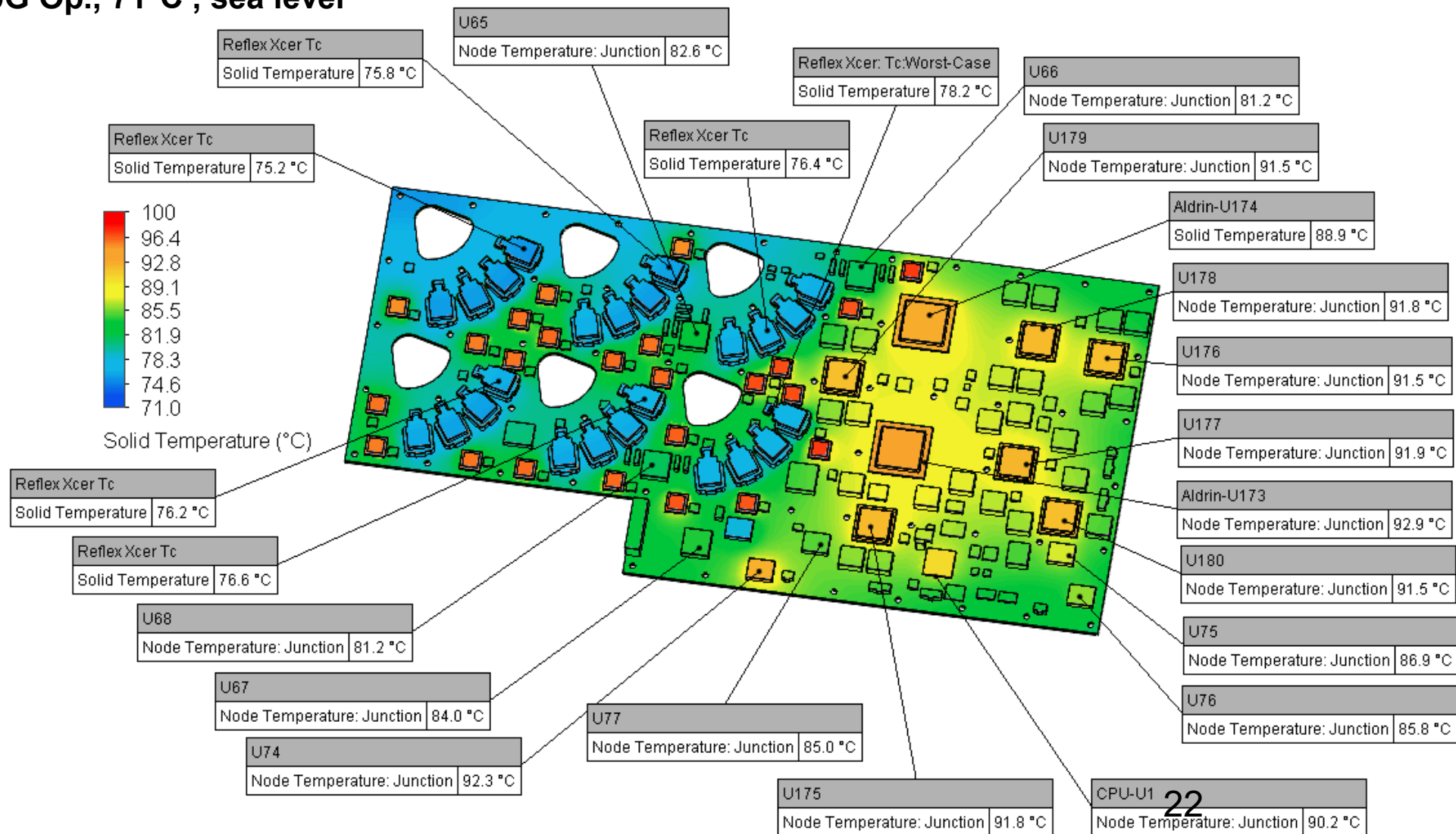

- Note: Surface plot is showing internal or junction temperatures for 2-Resistor network components.

CF-170300-220 Board Surface Temperature Plot

All 10G Op., 71°C , sea level

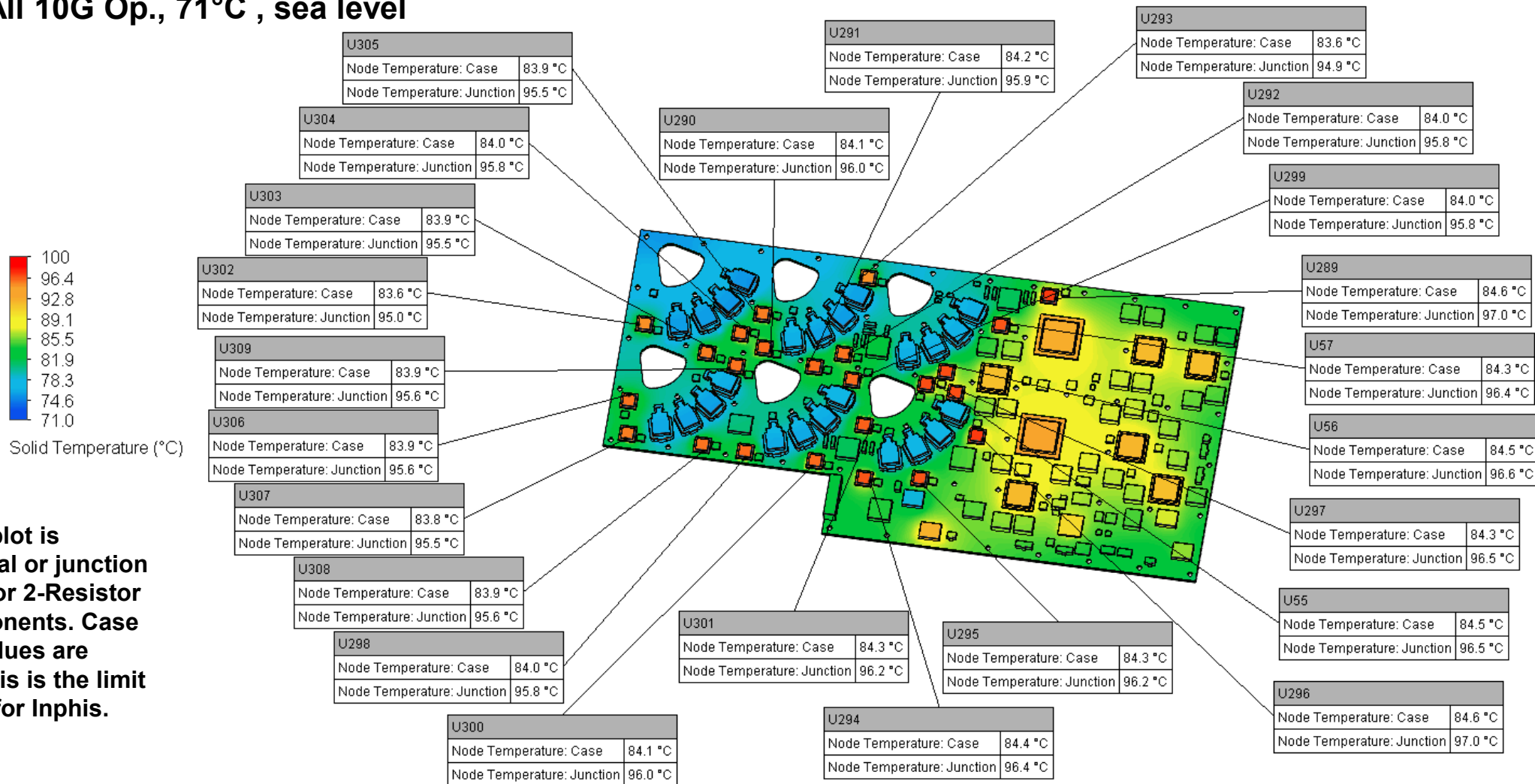

Note: Surface plot is showing internal or junction temperatures for 2-Resistor network components. Case temperature values are shown since this is the limit type specified for Inphis.

CF-170300-219 Board Surface Temperature Plot

All 10G Op., 71°C , sea level

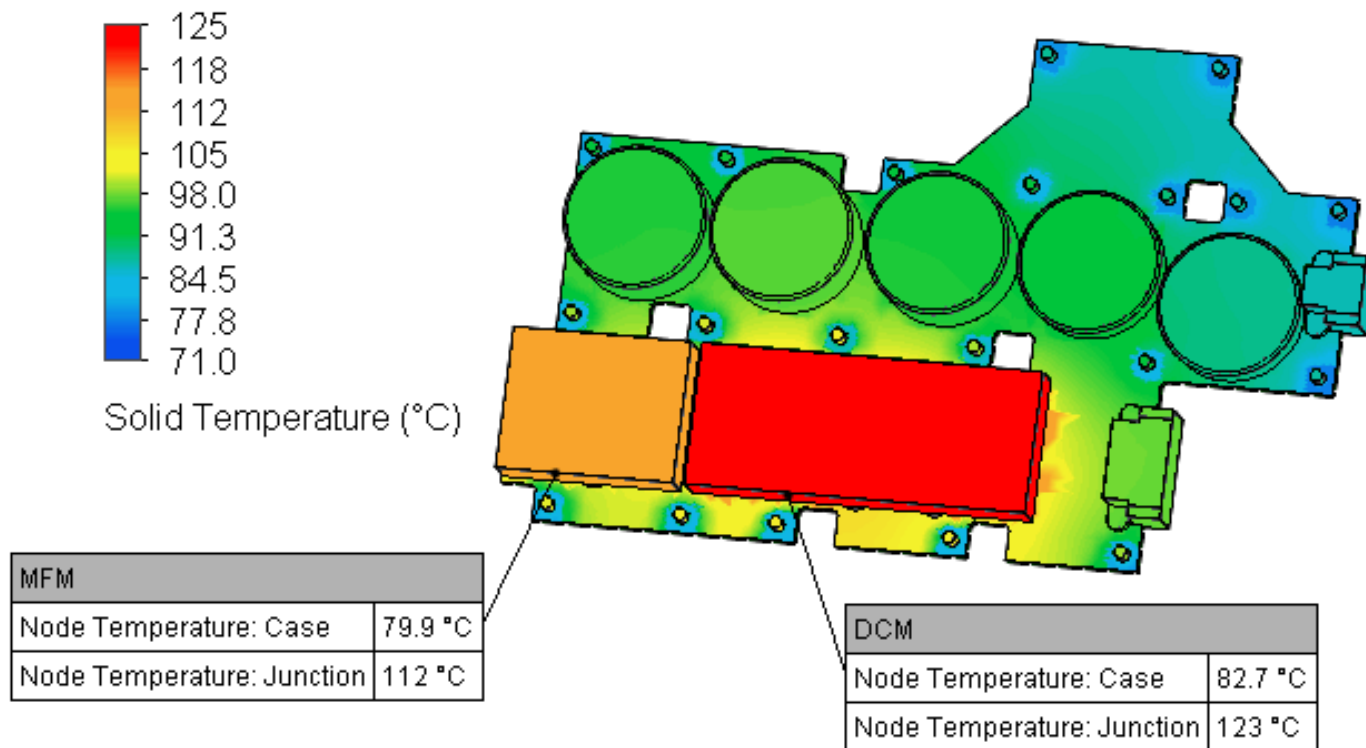

- Note: Surface plot is showing internal or junction temperatures for the MFM and DCM.

Housing Surface Temperature Plot

All 10G Op., 71°C , sea level

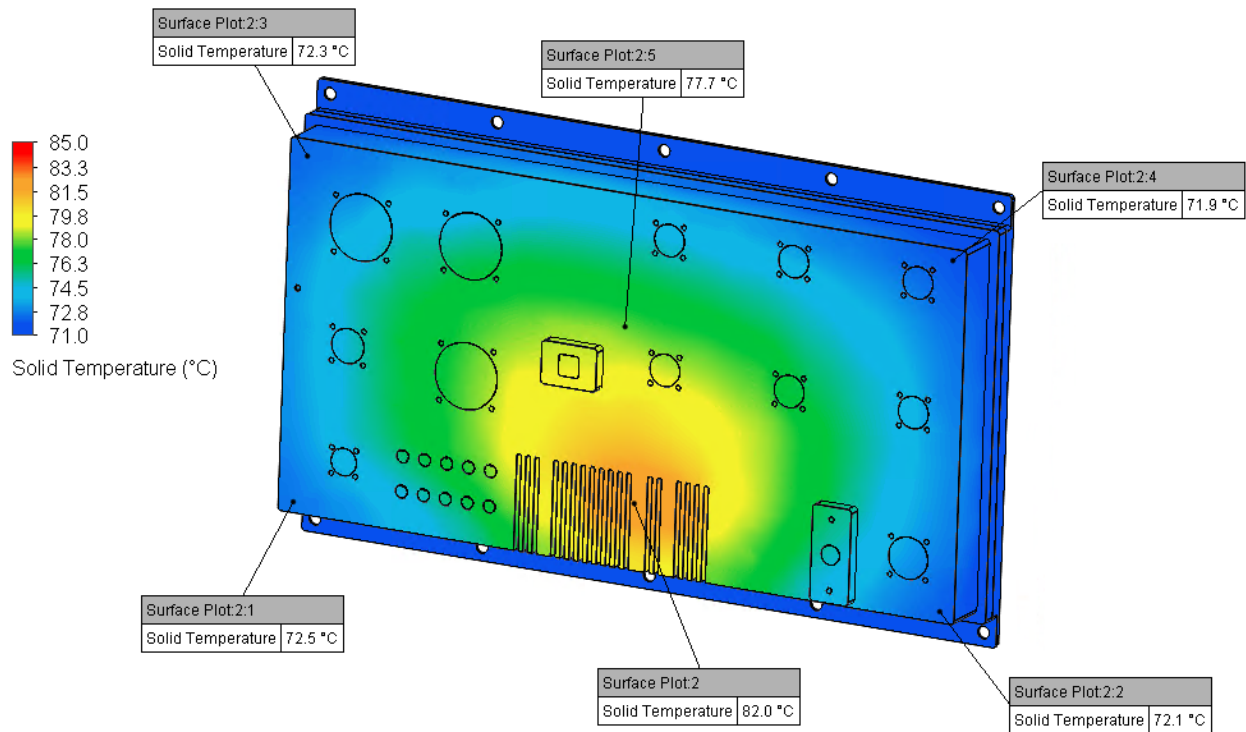

- There is a 10°C temperature gradient on the external surface of the front housing.

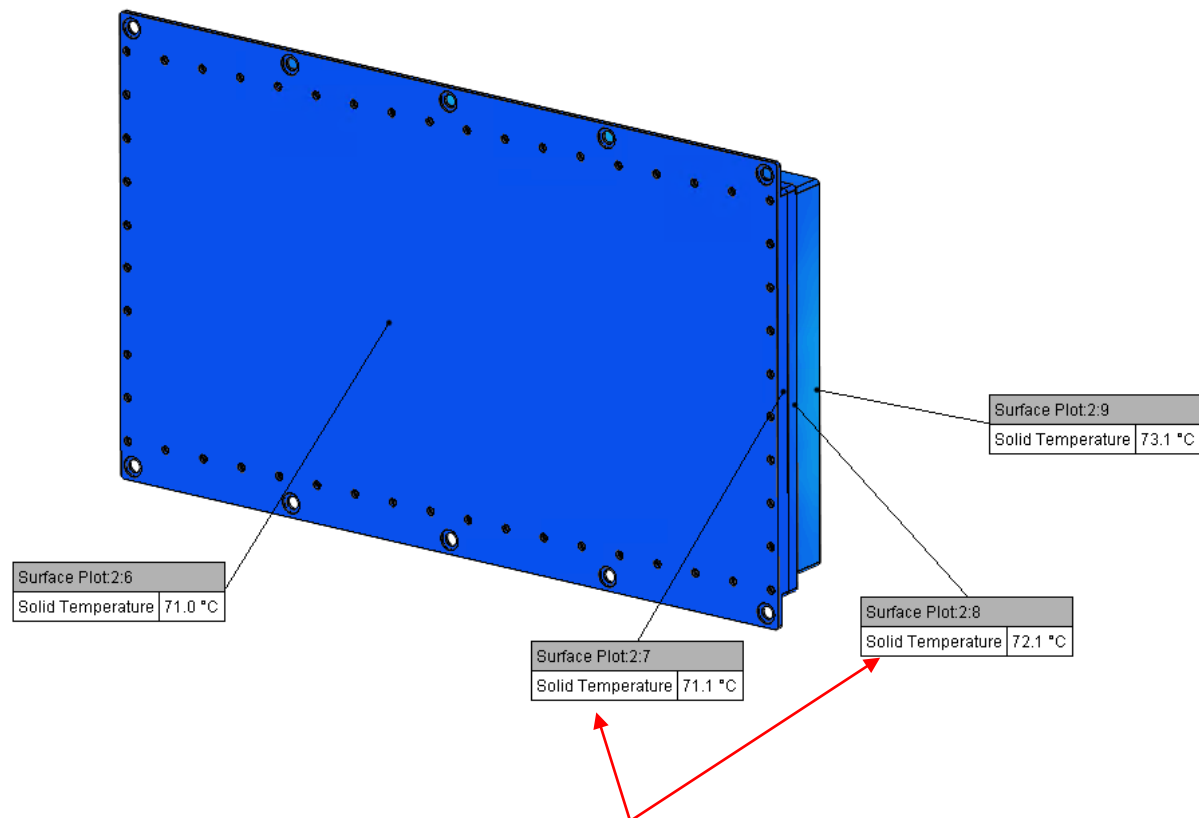

- There is only a ~1°C temperature gradient across the contact area between the rear cover and front housing.

Cutplane Temperature Plot: Mid-width Aldrin [U173] and Quad PHY [U177]

All 10G Op., 71°C , sea level

CUTPLANE LOCATION:

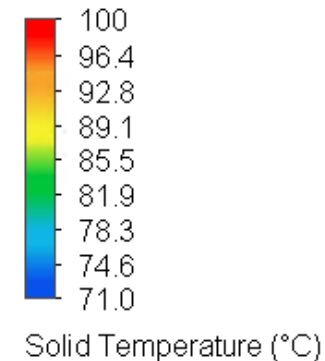
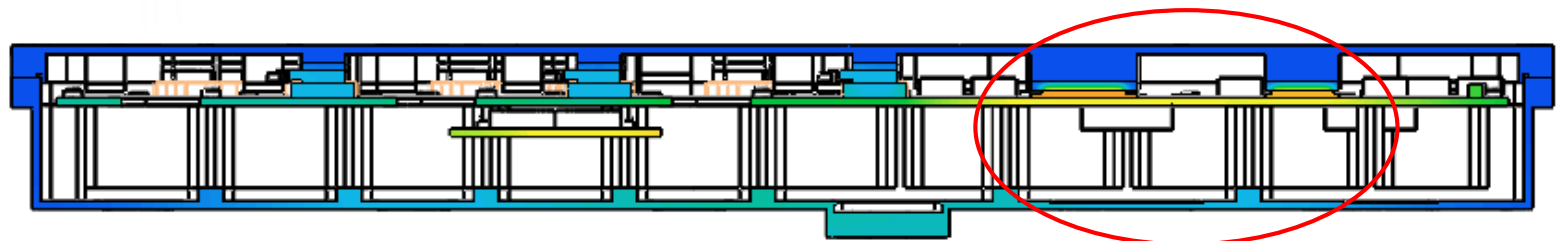
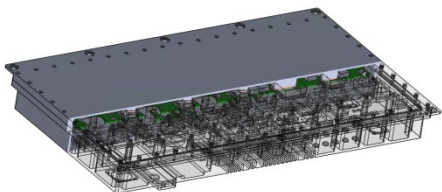

Note that the temperature gradient across the U173 thermal gap pad is 16.5°C. Note also that the temperature gradient across the U177 thermal gap pad is 15.6°C

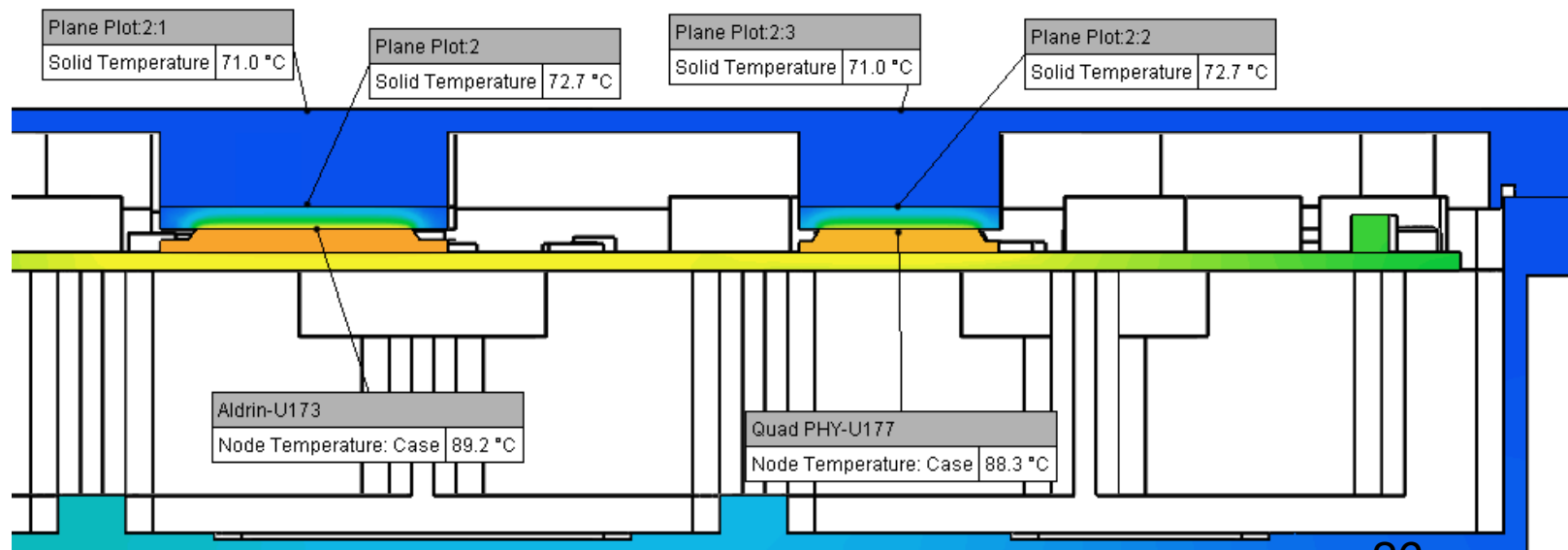

CF-170300-220 Board Surface Temperature Plot

Worst-case Power, 71°C , sea level

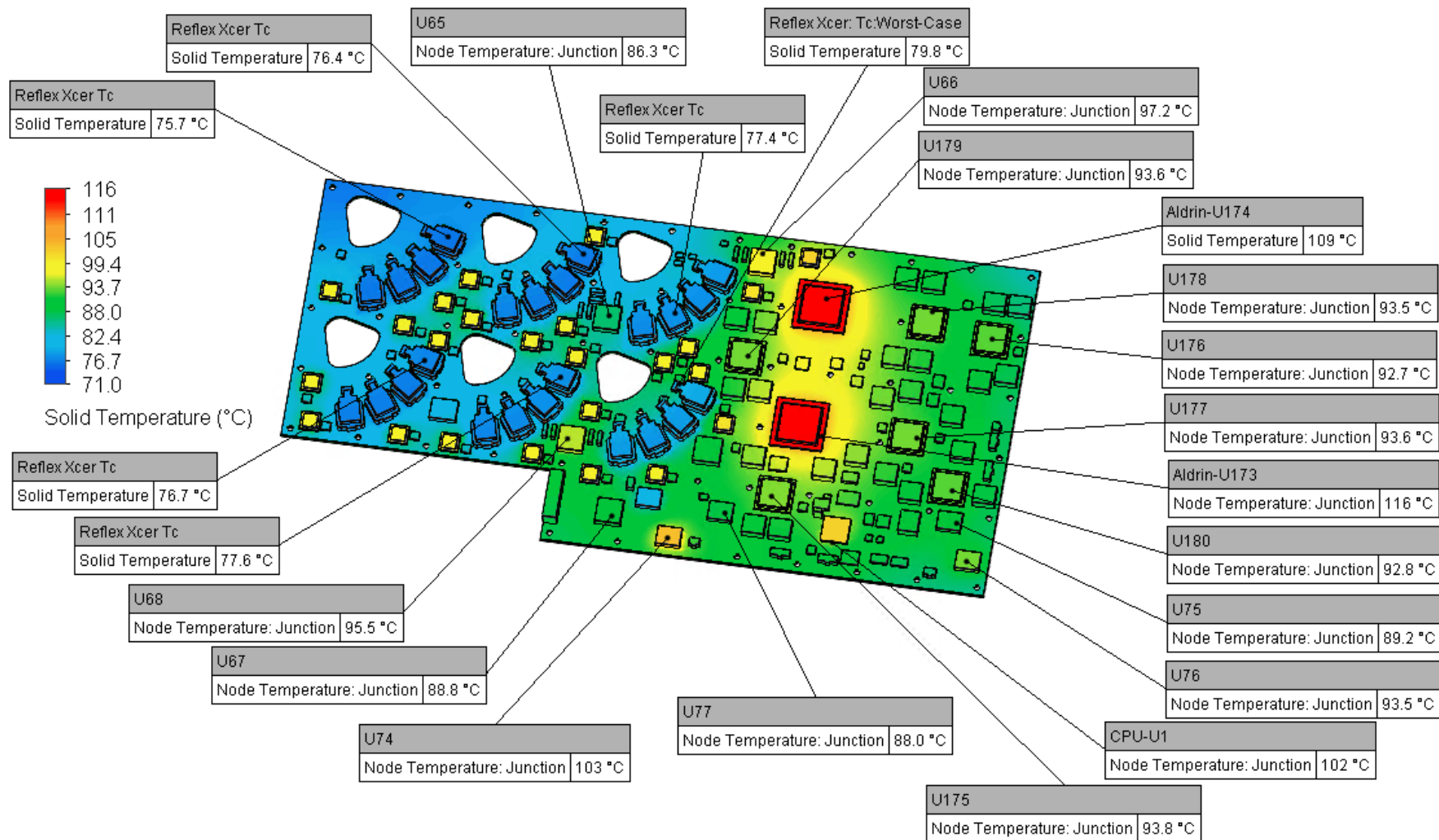

- Note: Surface plot is showing internal or junction temperatures for 2-Resistor network components.

CF-170300-220 Board Surface Temperature Plot

Worst-case Power, 71°C , sea level

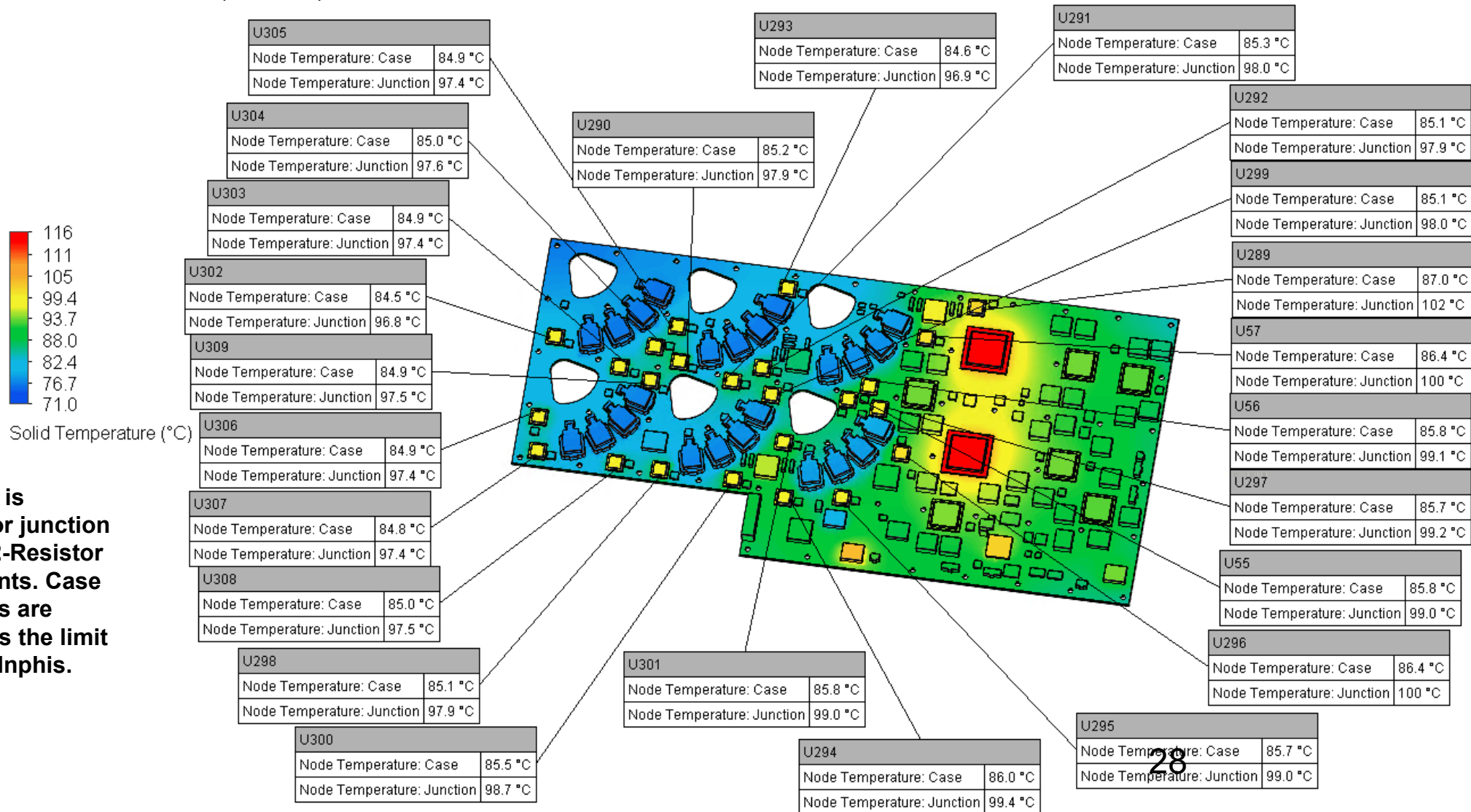

Note: Surface plot is showing internal or junction temperatures for 2-Resistor network components. Case temperature values are shown since this is the limit type specified for Inphis.

CF-170300-219 Board Surface Temperature Plot

Worst-case Power, 71°C , sea level

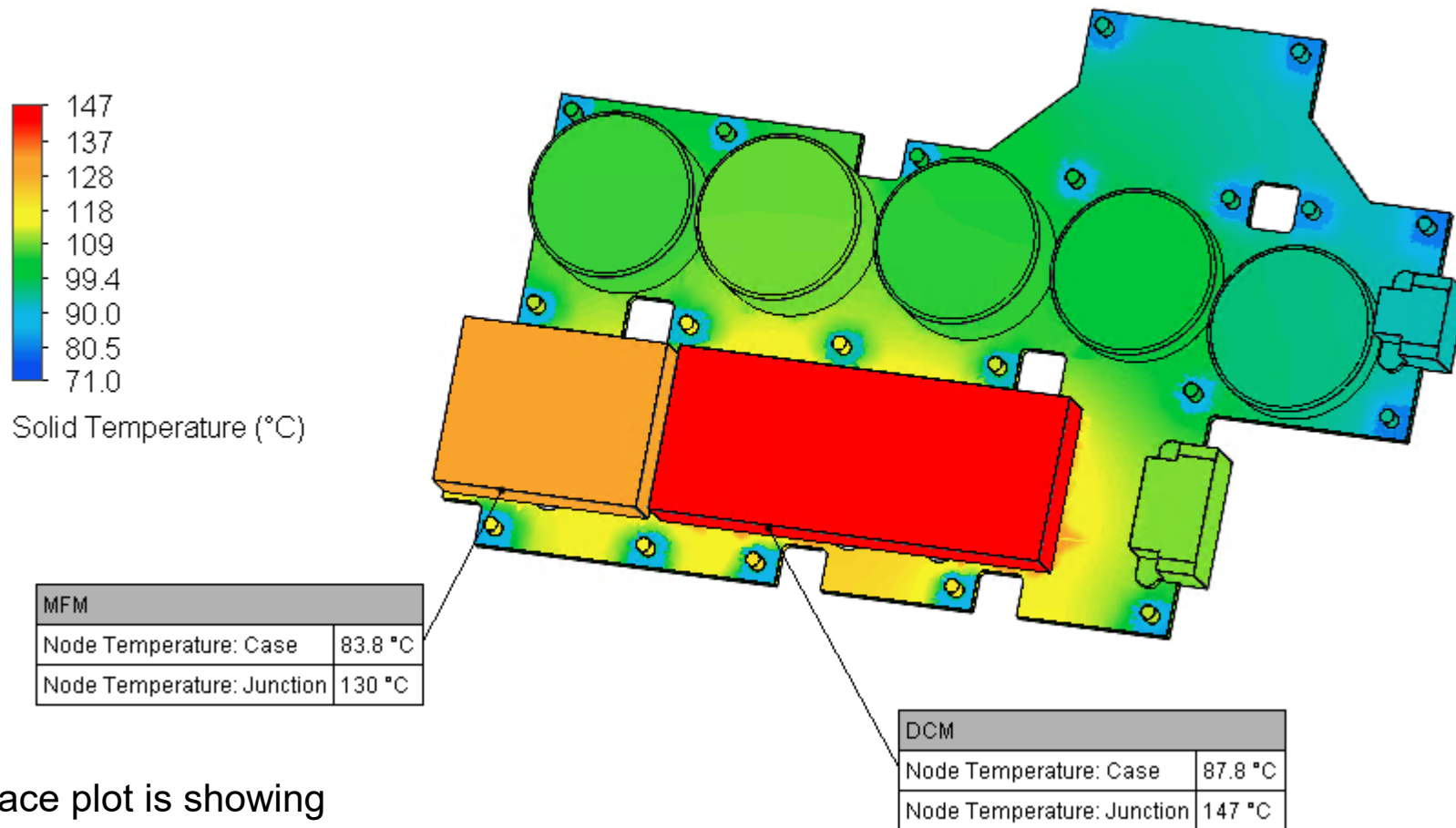

- Note: Surface plot is showing internal or junction temperatures for the MFM and DCM.

Recommendations

- Below is the table of recommended cooling surface/cold plate temperatures based on the current configurations:

Power Scenario	L3 Config.	All 10G Op.	Worst-case
Ambient Temp., °C	23	23	23
Recommended Cold Plate/Cooling Surface Temp., °C	23	23	23
Ambient Temp., °C	-54	-54	-54
Recommended Minimum Cold Plate/Cooling Surface Temp., °C	-40	-40	-40
Ambient Temp., °C	55	55	55
Recommended Cold Plate/Cooling Surface Temp., °C	55	55	45
Ambient Temp., °C	71	71	71
Recommended Cold Plate/Cooling Surface Temp., °C	71	66	45
Cold plate Surface Temperature Range:	-40C +71C	-40C +66C	-40C +45C

- Notes:

- ⇒ The cooling surface temperatures that do NOT match the corresponding ambient temperatures are highlighted in red.
- ⇒ For the -54°C ambient and for all corresponding power scenarios, the Reflex transceiver temperature determines the cooling surface temperature.
- ⇒ For the 71°C ambient and All 10G. Op. power scenario, the DCM internal temperature and the Inphis are marginal with 0.4 to 1.8°C margin. To allow for more margin for these components, it is recommended to run the cold plate at 66°C.
- ⇒ For the 71°C ambient and worst-case power scenario, the DCM internal temperature forms the basis of the cooling surface temperature. The DCM has the least margin and dictates the required cooling surface temperature.
- ⇒ As long as the cold plate surface temperature falls within the range shown in the above in the last row (highlighted in yellow), all components operate within their thermal limits.